

TOSHIBA



DVD PLAYER **SD-185/186EKE**

OWNER'S MANUAL



Introduction

SAFETY PRECAUTIONS

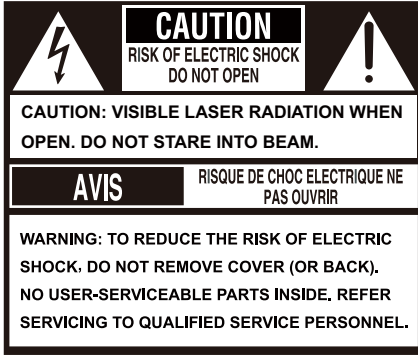

The lightning flash with arrowhead symbol, within an equilateral triangle, is intended to alert the user to the presence of uninsulated 'dangerous voltage' within the product's enclosure that may be of sufficient magnitude to constitute a risk of electric shock to persons.



The exclamation point within an equilateral triangle is intended to alert the user to the presence of important operating and maintenance (servicing) instructions in the literature accompanying the appliance.



The symbol for CLASS II (Double Insulation)

WARNING:

TO REDUCE THE RISK OF FIRE OR ELECTRIC SHOCK, DO NOT EXPOSE THIS APPLIANCE TO RAIN OR MOISTURE. DANGEROUS HIGH VOLTAGES ARE PRESENT INSIDE THE ENCLOSURE. DO NOT OPEN THE CABINET. REFER SERVICING TO QUALIFIED PERSONNEL ONLY.

CAUTION:

PLEASE READ AND OBSERVE ALL WARNINGS AND INSTRUCTIONS GIVEN IN THIS OWNER'S MANUAL AND THOSE MARKED ON THE UNIT. RETAIN THIS BOOKLET FOR FUTURE REFERENCE.

CAUTION:

USE OF ANY CONTROLS, ADJUSTMENTS, OR PROCEDURES OTHER THAN THOSE SPECIFIED HEREIN MAY RESULT IN HAZARDOUS RADIATION EXPOSURE.

Changes or modifications made to this equipment, not expressly approved by Toshiba, or parties authorized by Toshiba, could void the user's authority to operate the equipment.

IMPORTANT SAFETY INSTRUCTIONS

This unit has been designed and manufactured to assure personal safety. Improper use can result in electric shock or fire hazard. The safeguards incorporated in this unit will protect you if you observe the following procedures for installation, use and servicing. This unit is fully transistorized and does not contain any parts that can be repaired by the user. **DO NOT REMOVE THE CABINET COVER, OR YOU MAY BE EXPOSED TO DANGEROUS VOLTAGE. REFER SERVICING TO QUALIFIED SERVICE PERSONNEL ONLY.**

1. Read these instructions.
2. Keep these instructions.
3. Heed all warnings.
4. Follow all instructions.
5. Do not use this apparatus near water.
6. Clean only with dry cloth.
7. Do not block any ventilation openings. Install in accordance with the manufacturer's instructions.
8. Do not install near any heat sources such as radiators, heat registers, stoves, or other apparatus (including amplifiers) that produce heat.
9. Protect the power cord from being walked on or pinched particularly at plugs, convenience receptacles, and the point where they exit from the apparatus.
10. Only use attachments/accessories specified by the manufacturer.
11. Use only with the cart, stand, tripod, bracket, or table specified by the manufacturer, or sold with the apparatus. When a cart is used, use caution when moving the cart/apparatus combination to avoid injury from tip-over.
12. Unplug this apparatus during lightning storms or when unused for long periods of time.
13. Refer all servicing to qualified service personnel. Servicing is required when the apparatus has been damaged in any way, such as power-supply cord or plug is damaged, liquid has been spilled or objects have fallen into the apparatus, the apparatus has been exposed to rain or moisture, does not operate normally, or has been dropped.
14. Do not overload wall outlets; extension cords, or integral convenience receptacles as this can result in a risk of fire or electric shock.
15. Apparatus shall not be exposed to dripping or splashing and no objects filled with liquids, such as vases, shall be placed on the apparatus.
16. Keep your fingers well clear of the disc tray as it is closing. Neglecting to do so may cause serious personal injury.
17. Do not place a heavy object on or step on the apparatus. The object may fall, causing serious personal injury and serious damage to the apparatus.



18. Do not use a cracked, deformed, or repaired disc. These discs are easily broken and may cause serious personal injury and apparatus malfunction.
19. If the apparatus should smoke or smell, immediately disconnect the power cord from the wall outlet. Wait until the smoke or smell stops, then ask your dealer for a check and repair. Neglecting to do so may cause fire.
20. While it is thundering, do not touch the connecting cables or the apparatus.

SOME DOS AND DON'TS ON THE SAFE USE OF EQUIPMENT

This equipment has been designed and manufactured to meet international safety standards but, like any electrical equipment, care must be taken if you are to obtain the best results and safety is to be assured. So, please read the points below for your own safety. They are of a general nature, intended to help you with all your electronic consumer products and some points may not apply to the goods you have just purchased.

DO read the operating instructions before you attempt to use the equipment.

DO ensure that all electrical connections (including the mains plug, extension leads and inter-connections between the pieces of equipment) are properly made and in accordance with the manufacturer's instructions. Switch off and withdraw the mains plug before making or changing connections.

DO consult your dealer if you are ever in doubt about the installation, operation or safety of your equipment.

DO be careful with glass panels or doors on equipment.

DON'T remove any fixed cover as this may expose dangerous voltages.

DON'T obstruct the ventilation openings of the equipment with items such as newspapers, tablecloths, curtains, etc. Overheating will cause damage and shorten the life of the equipment.

DON'T allow electrical equipment to be exposed to dripping or splashing, or objects filled with liquids, such as vases, to be placed on the equipment.

DON'T place hot objects or naked flame sources such as lighted candles or nightlights on, or close to equipment. High temperatures can melt plastic and lead to fires.

DON'T use makeshift stands and NEVER fix legs with wood screws - to ensure complete safety always fit the manufacturer's approved stand or legs with the fixings provided according to the instructions.

DON'T listen to headphones at high volume, as such use can permanently damage your hearing.

DON'T leave equipment switched on when it is unattended unless it is specifically stated that it is designed for unattended operation or has a stand-by mode. Switch off using the switch on the equipment and make sure that your family know how to do this. Special arrangements may need to be made for infirm or handicapped people.

DON'T continue to operate the equipment if you are in any doubt about it working normally, or if it is damaged in any way - switch off, withdraw the mains plug and consult your dealer.

ABOVE ALL

- NEVER let anyone especially children push anything into holes, slots or any other opening in the case - this could result in a fatal electrical shock;**
- NEVER guess or take chances with electrical equipment of any kind**
- it is better to be safe than sorry!**

Introduction

CAUTION:

This Digital Video Disc Player employs a Laser System.

To ensure proper use of this product, please read this owner's manual carefully and retain for future reference.

Should the unit require maintenance, contact an authorized service location.

Use of controls or adjustments or performance of procedures other than those specified herein may result in hazardous radiation exposure.

To prevent direct exposure to laser beam, do not try to open the enclosure.

Visible and invisible laser radiation when open and interlocks defeated.

DO NOT STARE INTO BEAM.

CAUTION: These servicing instructions are for use by qualified service personnel only. To reduce the risk of electric shock do not perform any servicing other than that contained in the operating instructions unless you are qualified to do so.

Be aware that this equipment is still powered when in standby mode. To disconnect this equipment completely from the mains power, pull out the power plug from the wall outlet.

Environmental Information

All unnecessary packaging has been omitted. The packaging has been made easy to separate into three materials; cardboard (box), polystyrene foam (buffer) and polyethylene (bags, protective foam sheet).

Your DVD player consists of materials which can be recycled and reused if disassembled by a specialised company.

Please observe the local regulations regarding the disposal of packaging materials, exhausted batteries and old equipment.

LASER	
Type	Semiconductor laser InGaAlP(DVD) AlGaAs(CD)
Wave length	658 nm(DVD) 790 nm(CD)
Output Power	10.0 mW(DVD) 7.0 mW(VCD/CD)
Beam divergence	60 degrees

Where the MAINS plug or an appliance coupler is used as the disconnect device, the disconnect device shall remain readily operable.

In the spaces provided below, record the Model and Serial No. located on the rear panel of your DVD video player.

Model No. _____ Serial No. _____

Retain this information for future reference.

**WARNING:**
RISK OF ELECTRIC SHOCK!

Never attempt to service this product yourself. Opening and removing the covers may expose you to dangerous voltage or other hazards. Failure to follow this WARNING may result in death or serious injury. Refer all servicing not specified in this manual to a Toshiba Authorized Service Center.

Setup**Finding a suitable location**

- Place the set on a flat, hard and stable surface.
- Do not place the set on a carpet.
- Do not position the set on top of other equipment that might heat it up (e.g., receiver or amplifier).
- Do not put anything under the set (e.g.CDs, magazines).
- Install this unit near the AC outlet and where the AC power plug can be reached easily.

Space for ventilation

-Place the apparatus in a location with adequate ventilation to prevent internal heat build up. Allow at least 10 cm (4.0") clearance from the rear and the top of the set and 5 cm (2.0") from the left and right to prevent overheating.

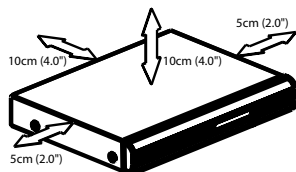
**Avoid high temperatures, moisture, water and dust**

- Apparatus shall not be exposed to dripping or splashing.
- Do not place any sources of danger on the apparatus (e.g., liquid filled objects, lighted candles).

Cleaning discs

Some problems occur because the disc inside the system is dirty (frozen picture, sound disruptions, picture distortions). To avoid these problems, discs should be cleaned on a regular basis.

To clean a disc, use a micro fibre cleaning cloth and wipe the disc from the center to the edge in a straight line. Do not touch the playback side of the disc.

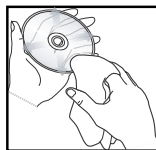
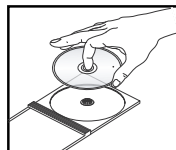
**CAUTION!**

Do not use solvents such as benzene, thinner, commercially available cleaners, or anti-static sprays intended for analog discs. Since the optical unit (laser) of the DVD system operates at a higher power than regular DVD or CD players, cleaning CDs intended for DVD or CD players may damage the optical unit (laser). Therefore, refrain from using a cleaning CD.

Moisture Condensation

Moisture condensation damages the DVD player. Please read the following carefully. Moisture condensation occurs, for example, when you pour a cold drink into a glass on a warm day. Drops of water form on the outside of the glass. In the same way, moisture may condense on the optical pick-up lens inside this unit, one of the most crucial internal parts of the DVD player.

If you use the DVD player in such a situation, it may damage discs and internal parts. Remove the disc, connect the power cord of the DVD player to the wall outlet, turn on the DVD player, and leave it for two or three hours. After two or three hours, the DVD player will have warmed up and evaporated any moisture. Keep the DVD player connected to the wall outlet and moisture condensation will seldom occur.













Region Codes

This DVD player is designed to support the Region Management System. Check the regional code number on the disc package. If the number does not match the player's region number (see table on page 5), the player may be unable to playback the disc.

Tips:

- It may not be possible to play CD-R/RW, DVD±R/RW, or DVD±R DL in all cases due to the type of disc or condition of the recording.
- If you are having trouble playing a certain disc, remove the disc and try a different one. Improperly formatted disc will not play on this DVD Player.

Introduction

Region	Discs that can be played	
U.S.A. and Canada regions		
U.K., Europe regions and Japan		
Asia Pacific, Taiwan, Korea		
Australia, New Zealand, Latin America		
Russia and India regions		
China, Calcos Islands, Walls and Futuna Islands		

DivX, DivX Certified, and associated logos are trademarks of DivX, Inc. and are used under license.

Manufactured under license from Dolby Laboratories. Dolby and the double-D symbol are trademarks of Dolby Laboratories.

Manufactured under license under U.S. Patent #: 5,451,942 & other U.S. and worldwide patents issued & pending. DTS and DTS Digital Out are registered trademarks and the DTS logos and Symbol are trademarks of DTS, Inc. ©1996-2007 DTS, Inc. All Rights Reserved.

EU Conformity Statement



"This product is marked with "CE" and complies therefore with the applicable harmonized European standards listed under the Low Voltage Directive 2006/95/EC and the EMC Directive 2004/108/EC."

Responsible for CE-marking is TOSHIBA INFORMATION SYSTEMS (U.K.) LTD, Toshiba Court, Weybridge Business Park, Addlestone Road, Weybridge, Surrey, KT15 2UL, United Kingdom.



Following information is only for EU-member States:

The use of the symbol indicates that this product may not be treated as household waste. By ensuring this product is disposed of correctly, you will help prevent potential negative consequences for the environment and human health, which could otherwise be caused by inappropriate waste handling of this product. For more detailed information about recycling of this product, please contact your local city office, your household waste disposal service or the shop where you purchased the product.



Pb, Hg, Cd

Following information is only valid EU-member States:

Disposal of batteries and/or accumulators

The crossed out wheeled dust bin symbol indicates that batteries and/or accumulators must be collected and disposed of separately from household waste.

If the battery or accumulator contains more than the specified values of lead (Pb), mercury (Hg), and/or cadmium (Cd) defined in the Battery Directive (2006/66/EC), then the chemical symbols for lead (Pb), mercury (Hg) and/or cadmium (Cd) will appear below the crossed out wheeled dust bin symbol.

By participating in separate collection of batteries, you will help to assure the proper disposal of products and batteries and thus help to prevent potential negative consequences for the environment and human health.

For more detailed information about the collection and recycling programmes available in your country, please contact your local city office or the shop where you purchased the product.

Unauthorized copying, broadcasting, public performance and lending of discs are prohibited.

This product incorporates copyright protection technology that is protected by method claims of certain U.S. patents and other intellectual property rights owned by Macrovision Corporation and other rights owners. Use of this copyright protection technology must be authorized by Macrovision Corporation, and is intended for home and other limited viewing uses only unless otherwise authorized by Macrovision Corporation. Reverse engineering or disassembly is prohibited.

Notes on copyright

The unauthorized recording, use, distribution, or revision of television programs, videotapes, DVDs and other materials, is prohibited under the Copyright Laws of the United States and other countries, and may subject you to civil and/or criminal liability.

Helpful hint: Before making or changing any connections, make sure that all the devices are disconnected from the power outlet.

Table of Contents

Introduction	
SAFETY PRECAUTIONS	1
IMPORTANT SAFETY INSTRUCTIONS	1-3
Setup	4
Cleaning discs	4
Moisture Condensation	4
Region Codes	4-5
Table of Contents	6
Connections	
Connecting to television	7-8
Connecting to a Stereo System	8
Connecting to a Digital AV Receiver	9
Connecting the power cord	9
Product Overview	
Front and Rear panels	10
Remote Control	11
Getting Started	
Inserting Batteries	12
Finding your viewing channel	12
Setting up Progressive Scan feature	12-13
Setting the language	13
Playback from Disc	
Playable discs	13-14
Playback Feature	
Starting disc playback	14
Basic playback control	14-15
Operations for video playback (DVD/VCD/SVCD)	15
Selecting various repeat functions	15-16
Viewing the disc playback Information	16
Special DVD Features	16
Special VCD and SVCD Features	16
Playing a DivX [®] Disc	17
Playing JPEG/Kodak picture CD	17-18
DVD menu Options	
Using the Language setup menu	18
Using the Video setup menu	18-20
Using the Audio setup menu	20
Using the Rating setup menu	20-21
Using the Misc (Miscellaneous) setup menu	21-22
Tray Lock	22
Others	
Specifications	23
Troubleshooting	24-25
Glossary	26

Connections

Connecting to television

IMPORTANT!

- You only need to make one video connection from the following options, depending on the capabilities of your television.
- Connect the DVD player directly to the television.

Using SCART socket

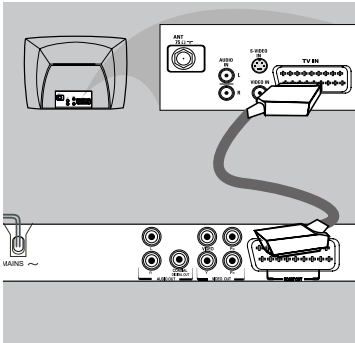

- 1 Use the scart cable to connect the DVD SCART OUT to the corresponding scart input socket on the TV (cable not supplied).
If your DVD player will not be connected to a Stereo System or AV Receiver to hear better sound, scart is enough for both audio and video connections.

Using Composite Video Jack(CVBS)

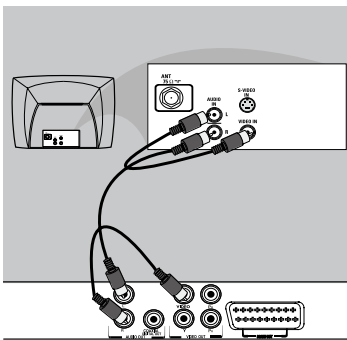

- 1 Use the composite video cable (yellow) to connect the DVD player's VIDEO(CVBS) jack to the video input jack(or labelled as A/V in, Video In or Composite) on the TV(cable not supplied).
To hear the sound of this DVD player through your

Helpful hint: Before making or changing any connections, make sure that all the devices are disconnected from the power outlet.

TV, use the audio cables(white/red)to connect AUDIO OUT(L/R)jacks of the DVD player to corresponding AUDIO IN jacks on the TV(cable not supplied).

Using Component Video Jacks(Y, P_B, P_R)

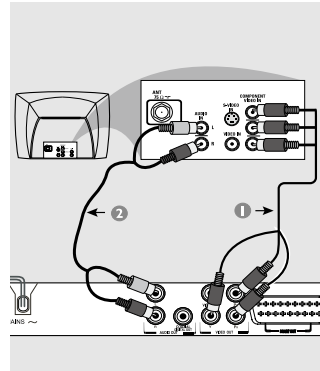

IMPORTANT!

-The progressive scan video quality is only possible when using Y, P_B, P_R and a progressive scan TV is required.

- 1 Use the component video cables (red/blue/green) to connect the DVD player's Y, P_B, P_R jacks to the corresponding Component video input jacks (or labelled as Y, P_B, P_R) on the TV (cable not supplied).
- 2 Use the audio cables (white/red) to connect AUDIO OUT (L/R) jacks of the DVD player to the corresponding AUDIO IN jacks on the TV(cable not supplied).
- 3 Proceed to page 12 for detailed Progressive Scan set up.

Using a RF modulator

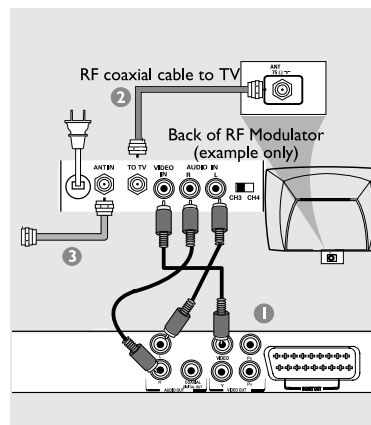

IMPORTANT!

-If your TV only has a single Antenna In jack (or labelled as 75 ohm or RF In), you will need an RF modulator in order to view the DVD playback on the TV.

- 1 Use the composite video cable (yellow) to connect the DVD player's VIDEO (CVBS) jack to the video input jack on the RF modulator (cable not supplied). To hear the sound of this DVD player through your TV, use the audio cables (white/red) to connect AUDIO OUT (L/R) jacks of the DVD player to the corresponding AUDIO IN jacks on the RF modulator (cable not supplied).
- 2 Use the RF coaxial cable (not supplied) to connect ANTENNA OUT or TO TV jack on the RF modulator to the ANTENNA IN jack on the television.
- 3 Connect the Antenna or Cable TV service signal to the ANTENNA IN or RF IN jack on the RF modulator. (It may have been connected to your TV previously. Disconnect it from the TV.)

Connecting to a Stereo System

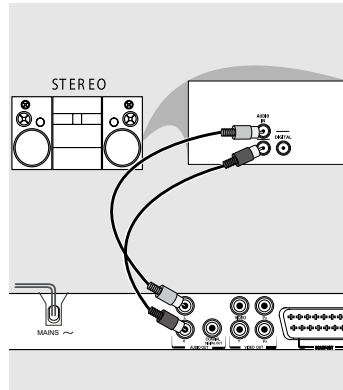

Stereo system has Dolby Pro Logic or Right/Left Audio In Jacks

- 1 Select one of the video connections (CVBS VIDEO IN, SCART IN or COMPONENT VIDEO IN) depending on the options available on your TV.
- 2 Use the audio cables (white/red) to connect AUDIO OUT (L/R) jacks of the DVD Player to the corresponding AUDIO IN jacks on the stereo system (cable not supplied).

Helpful hint: Before making or changing any connections, make sure that all the devices are disconnected from the power outlet.

Connecting to a Digital AV Receiver

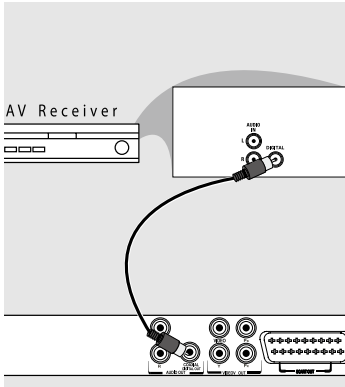

Receiver has a PCM, Dolby Digital or MPEG decoder

- 1 Select one of the video connections (CVBS VIDEO IN, SCART IN or COMPONENT VIDEO IN) depending on the options available on your TV.
- 2 Connect the COAXIAL jack of the DVD player to the corresponding Digital Audio In jack on your Receiver (cable not supplied).
- 3 Set the DVD Player's Digital Output to PCM or All depending on the capabilities of your Receiver (see page 20 {Digital Output}).

Tip:

-If the audio format of the Digital Output does not match the capabilities of your receiver, the receiver will produce a strong, distorted sound or no sound at all.

Connecting the power cord

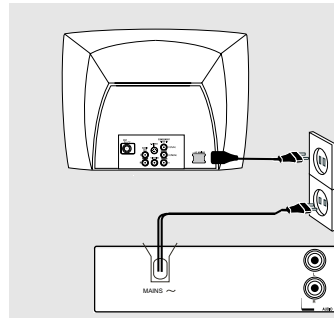

After everything is connected properly, plug in the AC power cord to the power outlet. Never make or change any connections with the power switched on.

Helpful hint: Before making or changing any connections, make sure that all the devices are disconnected from the power outlet.

Front and Rear panels

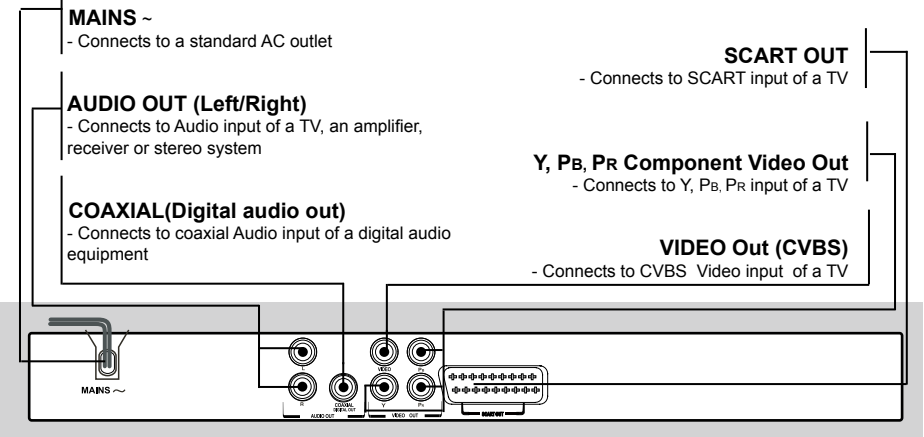
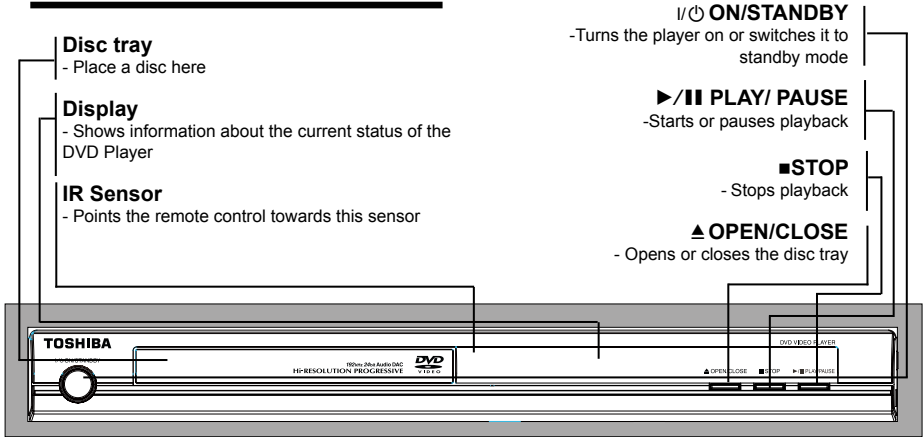

DVD display

The indicators vary depending on the kinds of disc you play.

<p>Chapter/Track number indicator</p> <p>Multifunctional indicator (indicates operating status or messages, etc.)</p> <p>No disc</p> <p>Bad disc</p>	<p>DVD video disc</p> <p>•During playback: Example</p> <p>Some discs may only display chapter numbers.</p>	<p>VIDEO CD</p> <p>•During playback: Example</p> <p>Some discs may only display track numbers.</p>	<p>Audio CD</p> <p>•During playback: Example</p> <p>Some discs may only display track numbers.</p>
		<p>OPEN</p>	<p>LOAD/CLOSE</p>

●"----" may also appear in other situation.

Product Overview

Remote Control

See the page in [] for details.

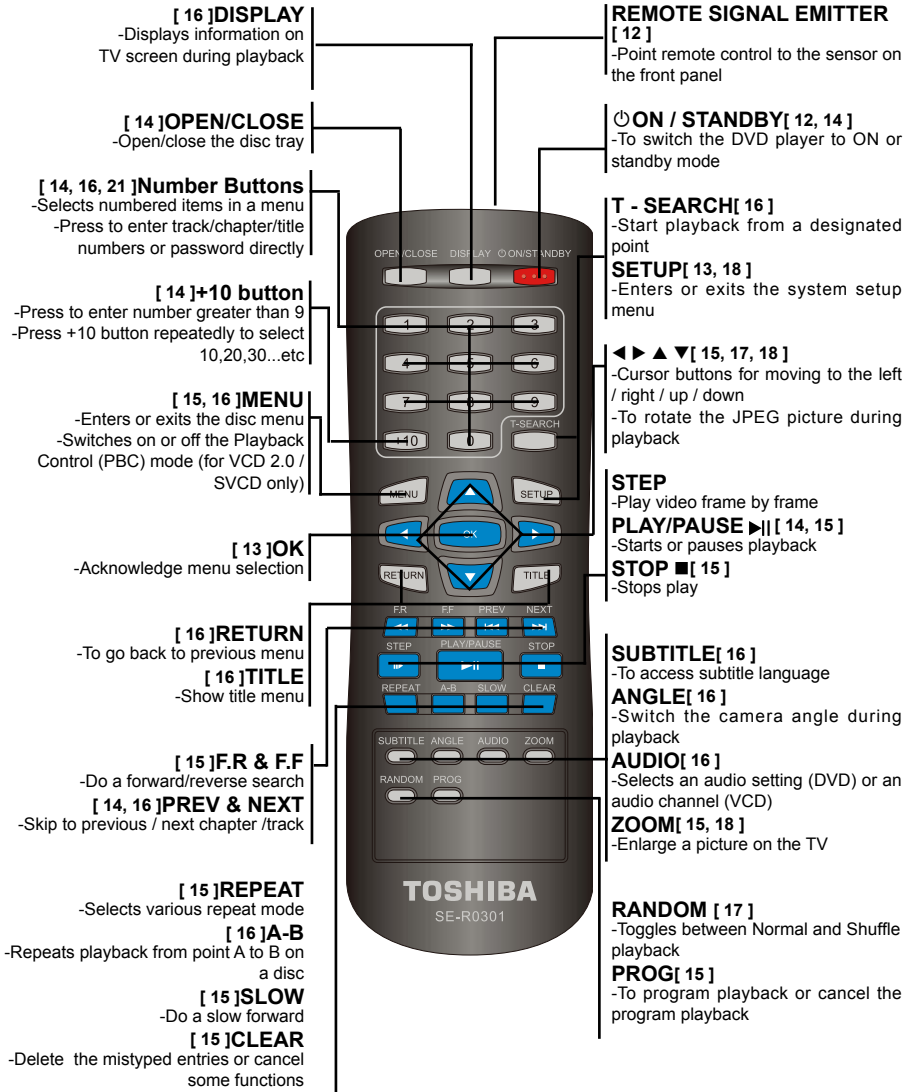

Inserting Batteries

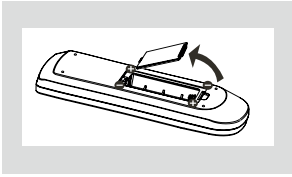

- 1 Open the battery compartment.
- 2 Insert two batteries type R03 or AAA, following the indications (+ / -) inside the compartment.
- 3 Close the cover.

CAUTION:

Never throw batteries into a fire.

Note:

- Be sure to use AAA size batteries.
- Dispose of batteries in a designated disposal area.
- Batteries should always be disposed of with the environment in mind. Always dispose of batteries in accordance with applicable laws and regulations.
- If the remote control does not operate correctly, or if the operating range becomes reduced, replace batteries with new ones.
- When necessary to replace batteries in the remote control, always replace both batteries with new ones. Never mix battery types or use new and used batteries in combination.
- Always remove batteries from remote control if they are dead or if the remote control is not to be used for an extended period of time. This will prevent battery acid from leaking into the battery compartment.

Using the Remote Control to Operate the System

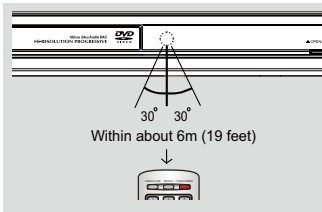

- 1 Aim the Remote Control directly at the remote sensor (IR) on the front panel.
- 2 Do not put any objects between the Remote Control and DVD Player while operating the DVD Player.

Finding your viewing channel

- 1 Press I/ON/STANDBY on the DVD player to turn it on.
- 2 Turn on the TV and set it to the correct video-in channel. You should see the blue DVD background screen.
 - Usually these channels are between the lowest

and highest channels and may be called FRONT, AV IN or VIDEO. See your TV's manual for more details.

→ Or, you may go to channel 1 on your TV, then press the Channel down button repeatedly until you see the Video In channel.

→ Or, the TV remote control may have a button that chooses different video modes.

→ Or, tune the TV until you can see the DVD player signal from the RF modulator (refer to your TV user manual).

- 3 If you are using external equipment, (such as audio system or receiver), turn it on and select the appropriate input source for the DVD player output. Refer to the equipment user's manual for detail.

Setting up Progressive Scan feature

(For Progressive Scan TV only)

The progressive scan display twice the number of frames per seconds than interlaced scanning (ordinary normal TV system). With nearly double the number of lines, progressive scan offers higher picture resolution and quality.

Before you start...

-Ensure that you have connected this DVD player to a progressive scan TV using the Y, Pb, Pr connection (see page 7).

-Ensure that you have completed the basic installation and set up.

- 1 Turn on your TV and select the video input connected to the DVD player (refer to your TV user manual).
- 2 Press ON/STANDBY on the remote control to turn on the DVD player.
 - The blue DVD background screen will appear on the TV.
- 3 Press SETUP.
- 4 Press ▲/▼ to select { Video }, then press ►.

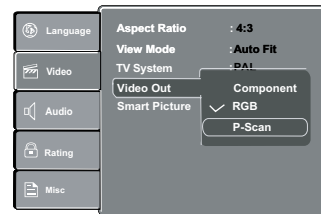

- 5 Press ▲/▼ to select { Video Out }, then press ►.
- 6 Select { P-Scan }, then press OK to confirm.
 - The menu will appear on the TV.

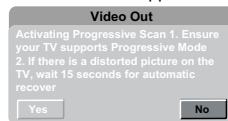

Helpful hint: Press ◀ to go back to previous menu item.
Press SETUP to exit the menu item.

Getting Started/Playback from disc

- Press **◀** to highlight { **Yes** } and press OK to confirm.
→ The reconfirmation menu will appear on the TV.

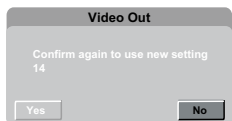

- Press **◀** to highlight { **Yes** } and press OK to confirm.
→ The setup is now completed and you can start enjoying the high quality picture.

To deactivate Progressive Scan manually:

- Wait for 15 seconds for the auto recovery.

OR

- Press OPEN/CLOSE **▲** on the DVD player to open the disc tray.
- Press number button '1' on the remote control for a few seconds.
→ The DVD background screen appears.

Tip:

-There are some progressive scan TVs and High-Definition TVs that are not fully compatible with this unit, resulting in the unnatural picture when playing back a DVD VIDEO disc in the progressive scan mode. In such a case, turn off the progressive scan feature on both the DVD player and your TV.

Setting the language

Choose your desired On-Screen Display(OSD)language where available.

On-Screen Display (OSD) Language

The On-screen language for the system setup menu will remain as you set it, regardless of various disc languages.



- Press SETUP.
- Press **▲/▼** to select { **Language** }
- Press **▶** to highlight { **OSD language** }, then press **▶**.
- Press **▲/▼** to select a language and press OK.

Audio, Subtitle and DVD menu language

You can choose your own preferred language or

Helpful hint: Press **◀** to go back to previous menu item.
Press SETUP to exit the menu item.

soundtrack from audio, subtitles and DVD menu languages. If the language selected is not available on the disc, the disc's default language will be used instead.

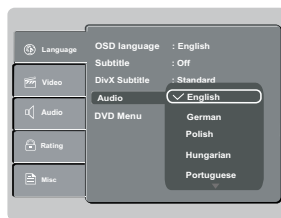

- Press SETUP.
- Press **▲/▼** to select { **Language** }, then press **▶**.
- Press **▲/▼** to highlight one of the options below, then press **▶**.
{ **Subtitle** }
Select this to change the subtitle language.
{ **Audio** }
Select this to change the disc soundtrack language.
{ **DVD Menu** }
Select this to change the language of the disc menu.
- Use **▲/▼** to select a language and press OK to confirm.
- Repeat steps 3 - 4 for other language settings.

IMPORTANT!

-DVD discs and players are designed with regional restrictions. Before playing a disc, make sure the disc is for the same zone as your player.

-If 'Ⓞ' appears on the TV screen when a button is pressed, it means the function is not available on the current disc or at the current time.

Playable discs

Using this DVD player, you can playback on the following discs. Some of these discs may be incompatible.

DVD Video disc(Digital Versatile Disc)



DVD±R/RW (DVD Recordable / Rewritable), DVD±R DL (Dual layer)
Audio/Video formats or



JPEG files.



CD-R (CD-Recordable)
Audio/Video format or
JPEG files.



Playback from disc/Playback Feature

CD-RW (CD-Rewritable)

Audio/Video format or JPEG files.



Audio CD (Compact Disc Digital Audio)



Video CD

(Formats 1.0, 1.1, 2.0)



Super Video CD



DVD is a trademark of DVD Format/Logo Licensing Corporation.

Because of problems and errors that can occur during the creation of DVD and CD software and/or the manufacture of DVD and CD discs, Toshiba cannot assure that this DVD player will successfully play every disc bearing the DVD and CD logos. If you happen to experience any difficulty playing a DVD and/or CD disc on this DVD player, please contact Toshiba Customer Service.

This DVD player requires discs/recordings to meet certain technical standards in order to achieve optimal playback quality. There are many different types of recordable disc formats (including CD-R files). Not all recordable discs will operate or produce optimal playback quality. The technical criteria set forth in this owner's manual are meant only as a guide.

You must obtain any required permission from copyright owners to download or use copyrighted content. Toshiba cannot and does not grant such permission.

Supported Formats

JPEG/Pictures

-The file extensions has to be '.JPG' and not '.JPEG'.

-JPEG/ISO format.

-Maximum of 5760×3840 resolution can be supported.

-Maximum file size: 10M.

-It can only display DCF-standard still pictures or JPEG pictures such as TIFF.

DivX®

-The file extensions has to be '.AVI', '.MPG' or '.MPEG'.

-DivX® 3.11, 4.x, 5.x and 6.0.

-Q-pel accurate motion compensation.

Global Motion Compensation (GMC) playback.

-Official DivX® Certified product.

-Plays all versions of DivX® video (including DivX® 6) with standard playback of DivX® media files.

Tips:

- Maximum 100 sessions for CD and 10 multi border for DVD are supported.

- For DVD-R, DVD-RW multi border, only finalized disc can be supported.

- For DVD+R and DVD+RW multi border, both finalized and unfinalized disc cannot be supported.

Starting disc playback

- 1 Turn on the TV and select the video input connected to the DVD player.
- 2 Press **ON / STANDBY** to turn on the DVD player.
- 3 Press **OPEN/CLOSE** to open the disc tray.
- 4 Place a disc onto the disc tray with the label facing up, then press **OPEN/CLOSE**.
→ For double-sided discs, load the side which you want to play facing up.
- 5 Playback may start automatically. If not, press **PLAY/PAUSE** **▶||**.
→ If a disc menu appears on the TV, see page 15 'Using the disc menu'.
→ If the parental control was activated for the inserted disc, you have to enter your four-digit password, see page 21.
→ For more playback features, see pages 14 - 18.

Tips:

-Do not overturn the DVD player while disc loading, playing or ejecting.

-Do not close the disc tray manually even if the power is switched off.

Basic playback control

Unless otherwise stated, all operations described are based on Remote Control use.

Pausing playback

- 1 During playback, press **PLAY/PAUSE** **▶||** to pause playback and display a still picture.
→ Sound will be muted.
- 2 To resume normal playback, press **PLAY/PAUSE** **▶||** again.

Skipping chapter/track

- Press **PREV** **◀◀** / **NEXT** **▶▶** to go to the previous or next chapter/track during playback.
→ When **PREV** **◀◀** is pressed after the first 5 seconds of playback, playback will start from the beginning of the current chapter/track. If you press the button within the first 5 seconds, playback will start from the beginning of the preceding chapter/track.
- Press **DISPLAY** to display the disc information for title/chapter/track.
- Use Number buttons to enter valid chapter / track number directly. For the track/chapter numbers which are greater than "9", use "+10" button. Each presses increases the number by 10. Then press the second digit of track/Chapter number.
→ The playback skips to the selected chapter / track.

Helpful hint: Some discs cannot be played on this DVD player due to the configuration and characteristics of the disc, or due to the condition of recording and authorizing software

Playback Feature

Stopping playback

- 1 During playback, press STOP ■.
 - The DVD player memorises the stopped point. Press PLAY/ PAUSE ►|| to resume playback from the location where you stopped playback.
 - If you press STOP ■ again, the DVD player will cancel the resume function.

Tips:

-Screen saver will start automatically if the disc playback is stopped for about 2 minutes.

-The player will automatically switch to Power Standby mode if you do not press any buttons for about 22 minutes after the disc has stopped playing.

Program playback

During playback, press PROG, then the OSD will appear as below:

For VCD:

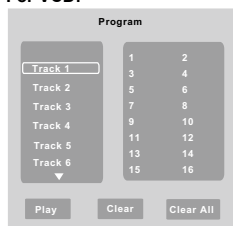

For DVD:

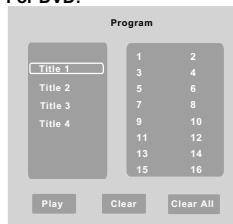

- 1 Use the ▲/▼ and OK button to select your desired title/chapter/track in the list.
- 2 When you have finished programming, press ► to move the cursor to the 'Play', then press the OK button or directly press PLAY/PAUSE ►|| button to start the program playback.
- 3 Press CLEAR or select 'Clear' to delete one by one from last chosen track / title /chapter or select 'Clear All' to clear all the programmed tracks/titles.
- 4 Press STOP twice to cancel program playback.

Operations for video playback (DVD/VCD/SVCD)

Using the disc menu

Depending on the disc, a menu may appear on the TV screen once you load in the disc.

To select a playback feature or item

- Use ◀/▶/▲/▼ or number buttons on the remote

Helpful hint: The operating features described here might not be possible for certain discs. Always refer to the instructions supplied with the discs.

control, then press OK to start playback.

To access or remove the menu.

- Press MENU on the remote control.

Zooming In

This function allows you to enlarge the picture on the TV screen and to pan through the enlarged picture.

- 1 During playback, press ZOOM repeatedly to display the picture with different scales.
 - Use ◀/▶/▲/▼ to pan through the enlarged picture.
 - Playback will continue.
- 2 Press ZOOM repeatedly to return to the original size.

Slow Motion

- 1 Press SLOW during playback to select the required speed: 1/2, 1/4, 1/8(forward only).
 - ➔Sound will be muted.
- 2 To return to normal speed, press PLAY/ PAUSE ►||.

Forward/ Reverse Searching

You can fast forward or fast reverse a disc during playback and select a desired search speed.

For DVD,VCD, SVCD,CD

- 1 During playback, press F.R/ F.F to select the required speed: X2, X4, X8, X16(backward or forward).
 - ➔Sound will be muted (DVD/VCD/SVCD) or intermittent (CD).
- 2 To return to normal speed, press PLAY / PAUSE ►||.

Selecting various repeat functions

Repeat play mode

The repeat play options vary depending on the disc type.

- 1 While playing a disc, press REPEAT repeatedly to choose a repeat options.

For DVD

- Repeat Chapter (currently playing chapter)
- Repeat Title (currently playing title)
- Off (cancel)

For Video CD, Audio CD

- Repeat Single (currently playing track)
- Repeat All (entire disc)
- Off (cancel)

For JPEG

- Repeat Single (currently playing file)
- Repeat All (current folder)
- Off (cancel)

Tip:

-For VCD2.0/SVCD discs, repeat playback is not possible if the PBC mode is turned on.

Repeating a section within a chapter/ track

You can repeat the playback of a specific segment within a chapter or track. To do this, you must mark the start and end of the segment you want.

- ① While playing a disc, press A - B at your chosen starting point.
- ② Press A - B again at your chosen end point.
→ The section will now repeat continuously.
- ③ To exit the sequence, press A - B.

Viewing the disc playback Information

You can view the disc information (such as current title/chapter/track number, total playing time or remaining time on the disc) without interrupting the disc playback.

- ① During playback, press DISPLAY repeatedly on the remote control.
→ The available disc information appears on the TV screen with the following sequence.

Time	00 : 03 : 33/01 : 24 : 46	(DVD)
Title		
Title	1/1	(DVD)
Chapter		
Chapter	2/8	
Audio		
Audio	1/1 D1 D6Ch Eng	(DVD)
Subtitle		
Subtitle	1/8 Eng	(DVD)
Angle		
Angle	1/4	(DVD)
Time		
Time	00 : 03 : 33/00 : 05 : 00	(VCD)
Track		
Track	3/24	(VCD PBC OFF)
OR		
Time		
Time	00 : 03 : 33/00 : 05 : 00	(VCD PBC ON)
PBC On		(VCD PBC ON)

Title/Chapter/Track/Time selection

- ① Press T-SEARCH, then press ▲/▼ to select { Time }, { Title }, { Chapter } or { Track }.

For VCD :

PBC OFF

Track	---	
Time	---:--	(desired time of the current track)
Disc Time	---:--	(desired time of the disc)

For DVD:

Title	---	
Chapter	---	
Time	---:--	(desired time of the disc)

- ② Use the number buttons (0-9) to input a valid number or time("0"cannot be input as the first number). (This function only apply to DVD/VCD.)
- ③ Press OK to confirm.

→ The playback skips to the selected title/chapter/ track/time.

Helpful hint: The operating features described here might not be possible for certain discs. Always refer to the instructions supplied with the discs.

Angle

- When {Angle} information appears on the screen, press ANGLE button on the remote control repeatedly to switch between different angles.
→ Playback will go to the selected angle.

Special DVD Features

Playing a Title

- ① Press TITLE.
→ The disc title menu appears on the TV screen.
- ② Use ▲/▼/◀/▶ or number buttons (0-9) to select a play option.
- ③ Press OK to confirm.

Changing the Audio Language

For DVD :

Press AUDIO repeatedly to select different audio languages.

Changing the Audio Channel

For VCD :

● Press AUDIO to select the available audio channels provided by the disc (Left, Right, Mix, Stereo).

Subtitles

● Press SUBTITLE repeatedly to select different subtitle languages.

Special VCD and SVCD Features

For VCD with Playback Control (PBC) feature (version 2.0 only)

● Press MENU to toggle between ' PBC On ' and ' PBC Off '.

→ If you select ' PBC On ', the disc menu (if available) will appear on the TV.

→ Use the number buttons (0-9) to select a play option.

● Press PREV |◀◀ / NEXT ▶▶| to go to the previous or next track.

→ When PREV |◀◀ is pressed after the first 5 seconds of playback, playback will start from the beginning of the current track. If you press the button within the first 5 seconds, playback will start from the beginning of the preceding track.

● During playback, pressing RETURN will return to the menu screen (if PBC is on).

If you want to skip the index menu and playback directly from the beginning.

● Press MENU on the remote control to turn the PBC off.

Playback Feature

Playing a DivX® Disc

This DVD player supports the DivX® movie playback that you download from your computer onto a CD-R/RW or DVD±R/RW (see pages 13-14 for more information).

- 1 Load a DivX® disc.
The data disc menu appears on the TV screen.
- 2 Press ▲/▼ to select the folder and press OK to open the folder.
- 3 Press ▲/▼ to select a file.
- 4 Press OK to confirm.
 - Press SUBTITLE on the remote control will turn on or off the subtitle.
 - If multilingual subtitles are embedded on the DivX® disc, pressing SUBTITLE will change the subtitle language during playback.

Tips:

-Subtitle files with the following filename extensions (.srt, .smi, .sub, .ssa, .txt) are supported but do not appear on the file navigation menu.

-The subtitle filename(.sub) has to be saved under the same filename as the movie(.avi) in the same folder.

[For example, Folder A: abc.avi and abc.sub]

Playing JPEG/ Kodak picture CD

IMPORTANT!

You have to turn on your TV and set to the correct Video In channel. (See page 12, 'Finding your viewing channel').

General Operation

- 1 Load a disc.
→ The disc reading time may exceed 30 seconds due to the complexity of the directory/file configuration.
→ The data disc menu information appears on the TV screen.



- 2 Press ▲ / ▼ to select the folder and press OK to open the folder.
- 3 Press ▲ / ▼ to select a file.
- 4 Press OK to confirm.

Tips:

- If you highlight on a jpeg file, a preview will appear.
- During JPEG playback, the LED will display the file number.

Playback Selection

During playback, you can;

Helpful hint: The operating features described here might not be possible for certain discs. Always refer to the instructions supplied with the discs.

- Press PREV I◀◀ / NEXT ▶▶ to select the previous/next file in the current folder.
- Press PLAY/PAUSE ▶|| repeatedly to pause/resume playback.

Play modes for DivX® /Audio CD/JPEG

You are able to modify the play modes through the toolkit which appears on the right of below picture on the screen. Press ◀ / ▶ to navigate between the windows and ▲ / ▼ buttons to select files/ tracks or play mode items. Then press OK. Please refer to below steps to playback files /tracks in the **Program View list**:

- 1 Select **Edit Mode** in the toolkit then press OK to start edit mode.
- 2 Select a file/track or more files/tracks you want in the original view list.
- 3 Select **Add To Program** in the toolkit then press OK. '√' will disappear from screen. It means that the files/tracks you have selected already added into the **Program View list**.
- 4 Select **Program View** in the toolkit then press OK to open the file/track in the Program View list that you already selected in step 2.
- 5 Press PLAY / PAUSE ▶|| to playback all files/tracks in the Program View list.

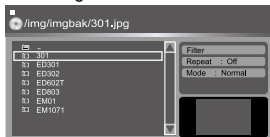

The Toolkit has the following play mode items:

- **Filter (Audio/Photo/Video)**: Sets file filters (Filter is not applicable to Audio CD.)
- **Repeat (Off/Single/ All)**:
 - Off**: Resumes normal playback
 - Single**: Repeats the current track/file.
 - All**: Repeats all files on the current folder or all tracks on the disc.
- **Mode(Normal/Shuffle)**
This mode can also be toggled by using RANDOM button.
 - Normal**: Resumes Normal playback
 - Shuffle**: Playbacks track/file in random order.
- **Edit Mode**: Program operation works only when Edit Mode is selected. After finished storing the files/ tracks you want into the Program View list, select "Edit Mode" again and press OK to release edit mode.
- **Program View**: To view tracks/files in the Program View list. It is disabled if the Program View list is empty.
- **Add To Program**: Add files/tracks to the Program View list. It is disabled if Edit Mode is not selected. (The maximum number of files/tracks can be added is 30.)
- **Browser View**: To view files/tracks in the Original View list.
- **Clear Program**: Delete the files/tracks in the

Program View list.

→ Select a file/track or more you want to delete in stop mode. '√' will appear besides the deleted file/track. Select **Clear Program** and then press OK. It is disabled if Edit mode is not selected.

Zoom picture (JPEG)

- During playback, press ZOOM repeatedly to display the picture with different scales.
- Use ▲ / ▼ / ◀ / ▶ to view the zoomed picture.

Rotate picture (JPEG)

- During playback, press ▲ / ▼ / ◀ / ▶ to rotate the picture on the TV screen.
- ▲ / ▼ : flip the picture vertically by 180°
- ◀ : rotate the picture anti-clockwise by 90°
- ▶ : rotate the picture clockwise by 90°

Tip:

-It may not be possible to play certain JPEG disc due to the configuration and characteristics of the disc or condition of the recording.

This DVD Player setup is carried out via the TV, enabling you to customise the DVD player to suit your particular requirement.

Using the Language setup menu

- 1 Press SETUP on the remote control.

→ The system setup menu appears.



- 2 Press ▲ / ▼ to select { **Language** }, then press ▶.
- 3 Press ▲ / ▼ to select an item, then press ▶ to access.

Example: { **OSD Language** }

→ The options for the selected item appears.

→ If the selection in the menu is greyed out, that means the feature is not available or not possible to change at the current state.

- 4 Use ▲ / ▼ to select a setting and press OK to confirm.

Example: { **English** }

→ The setting is selected and setup is completed.

- 5 To exit, press SETUP.

OSD Language

This menu contains various language options for the language displayed on the screen.

Subtitle/Audio/DVD Menu/DivX Subtitle

These menus contains various language options for audio, subtitle, DVD menu and DivX subtitle which may be recorded on the DVD.

Tips:

-Some DVD video discs may be set to display subtitles in a different language other than you selected. A prior subtitle language may be programmed on the disc.

-Some DVD video discs allow you to change subtitle selections only via the disc menu. If this is the case, press the MENU button and choose the appropriate subtitle language from the selection on the disc menu.

-Some DVD video discs may not be played in a different audio language that you selected. A prior language may be programmed on the disc.

-Some DVD discs may not include your pre-selected language. In this case, the DVD player automatically displays discs menus consistent with the disc's initial language setting.

DivX® Subtitle

If your DivX® files include a subtitle file (see page 17 for the supported file formats), you may select a supported DivX® subtitle language by region.

- 1 In 'Language', press ▲ / ▼ to select { **DivX Subtitle** }, then press ▶.

{ Standard }

Albanian, Danish, Dutch, English, Finnish, French, Gaelic, German, Italian, Kurdish (Latin), Norwegian, Portuguese, Spanish, Swedish and Turkish.

{ Central European }

Albanian, Croat, Czech, Dutch, English, German, Hungarian, Irish, Polish, Romanian, Slovak, Slovene and Sorbian.

{ Cyrillic }

Bulgarian, Belorussian, English, Macedonian, Moldavian, Russian, Serbian and Ukrainian.

{ Greek }

English and Modern Greek only.

{ Hebrew }

English and Modern Hebrew only.

- 2 Use ▲ / ▼ to select a setting and press OK to confirm.

Using the Video setup menu

- 1 Press SETUP on the remote control.

→ The system setup menu appears.

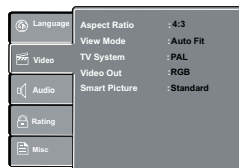

- 2 Press ▲ / ▼ to select { **Video** }, then press ▶
- 3 Press ▲ / ▼ to select an item, then press ▶ to access.

Example: { **Video Out** }

Helpful hint: Press ◀ to go back to previous menu item.
Press SETUP to exit the menu item.

DVD Menu Options

→ The options for the selected item appears.
→ If the selection in the menu is greyed out, that means the feature is not available or not possible to change at the current state.

- Use ▲ / ▼ to select a setting and press OK to confirm.

Example: { **P-Scan** }

→ The setting is selected and setup is completed.

- To exit, press SETUP.

Aspect Ratio

The picture shape can be adjusted to fit your TV and the format must be available on the playback disc. Otherwise, the TV display will not affect the picture during playback.

- In 'Video', press ▲ / ▼ to select { **Aspect Ratio** }, then press ►.
{ **4:3** }
Select this if you have a normal TV. A 'wide-screen' source display with black bars on the top and bottom will be displayed on the TV screen.

Select this for wide-screen TV (frame ratio 16:9).

- Use ▲ / ▼ to select a setting and press OK to confirm.

View Mode

Use view mode to scale an image that fits to the TV screen's width and height.

- In 'Video', press ▲ / ▼ to select { **View Mode** }, then press ►.
{ **Fill** }
Fill the screen with decoded image.
{ **Original** }
Display image as its original size.
{ **Height Fit** }
Fit the screen height with image height.
{ **Width Fit** }
Fit the screen width with image width.
{ **Auto Fit** }
Automatically display the decoded image on screen at a suitable size.
{ **Pan Scan** }
Automatically display decoded image on full screen without distortion.

- Use ▲ / ▼ to select a setting and press OK to confirm.

Tip:

- Depending on the type of disc, you may not be able to view the mode as selected.

TV System

The video standard of the DVD player output can be selected from "NTSC", "PAL" or "Multi".

{ **NTSC** } : Select if your TV system is NTSC.

{ **PAL** } : Select if your TV system is PAL.

{ **Multi** } : The DVD video player automatically identifies PAL or NTSC video system of a disc.

Connect a multisystem TV (PAL/NTSC compatible) to view a picture.

A playback picture may be distorted when detected a signal change between PAL and NTSC on the disc. For the case of Progressive mode, your multisystem TV must be able to support 525p and 625p.

Video Out

The video output of the DVD player can be selected as "Component", "RGB" or "P-Scan".

- In 'Video', press ▲ / ▼ to select { **Video Out** }, then press ►.

{ **Component** }

Select this for component video connection.

{ **RGB** }

Select this for Scart connection.

{ **P-Scan** }

Select this when you connect your DVD player to your TV, which has component video inputs that supports progressive scan.

- Use ▲ / ▼ to select a setting and press OK to confirm.

Smart Picture

This DVD player provides four predefined sets of picture color settings.

- In 'Video', press ▲ / ▼ to select { **Smart Picture** }, then press ►.

{ **Standard** }

Select this for a preset standard picture setting.

{ **Vivid** }

Select this to make the picture brighter.

{ **Cool** }

Select this to make the picture softer.

{ **Personal** }

Select this to personalize your picture color by adjusting the brightness, contrast, tint and color (saturation).

- Use ▲ / ▼ to select a setting and press OK to confirm.

- If you select { **Personal** }, then proceed to steps 4~7.

→ The setup menu appears.

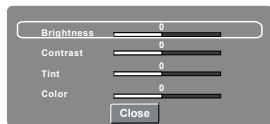

- Press ▲ / ▼ to highlight one of the following options.

Brightness

Increase the value to brighten the picture or vice versa. Choose zero (0) for average setting.

Contrast

Increase the value to sharpen the picture or vice versa. Choose zero (0) to balance the contrast.

Tint

Increase the value to darken the picture or vice versa. Choose zero (0) for average setting.

Color

Increase the value to enhance the colour in your picture or vice versa. Choose zero (0) to balance the colour.

- Press ◀ / ▶ to adjust the setting that best suits your personal preference.

Helpful hint: Press ◀ to go back to previous menu item.
Press SETUP to exit the menu item.

- Repeat steps 4~5 to adjust your picture preference.
- Press ▲ / ▼ to select 'Close' and press OK to confirm.

Using the Audio setup menu

- Press SETUP on the remote control.
→ The system setup menu appears.

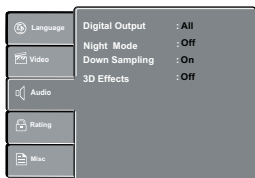

- Press ▲ / ▼ to select { Audio }, then press ►.
- Press ▲ / ▼ to select an item, then press ► to access.
Example: { Night Mode }
→ The options for the selected item appears.
→ If the selection in the menu is greyed out, that means the feature is not available or not possible to change at the current state.
- Use ▲ / ▼ to select a setting and press OK to confirm.
Example: { On }
- The setting is selected and setup is completed.
To exit, press SETUP.

Digital Output

Select this if you connect to a multichannel decoder/receiver.

- In 'Audio', press ▲ / ▼ to select { Digital Output }, then press ►.

{ All }
Select this if the connected device has a built-in multichannel decoder that supports one of the multichannel audio format (Dolby Digital, DTS).

{ PCM }
Select this if the connected device is not capable of decoding multichannel audio. The DVD player will convert the Dolby Digital signal to PCM (Pulse Code Modulation).

{ Off }
To deactivate the digital audio output. For example, if you use the AUDIO OUT jacks to connect to a TV or stereo system.

- Use ▲ / ▼ to select a setting and press OK to confirm.

Tip:

-When playing MPEG and set Digital Output to {All}, the player will output PCM signals.

Night Mode

This mode optimizes playback of sound at low volume. High volume outputs will be softened and low volume outputs are brought upward to an audible level.

- In 'Audio', press ▲ / ▼ to select { Night Mode }, then press ►.
{ On }
Select this to set low volume output. This feature is only available for movie discs with Dolby Digital mode.
{ Off }
Turns off night mode feature. Select this to enjoy the surround sound with its full dynamic range.
- Use ▲ / ▼ to select a setting and press OK to confirm.

Down Sampling

You can enable and disable the digital signal for better sound output quality.

- In 'Audio', press ▲ / ▼ to select { Down Sampling }, then press ►.
{ Off }
If your amplifier / decoder is compatible with 96 KHz PCM, select " Off ". Sound is sampled at 96 KHz.
{ On }
If your amplifier / decoder is not compatible with 96 KHz PCM, select " On ". Sound recorded at 96 KHz is down sampled to 48 KHz.
- Use ▲ / ▼ to select a setting and press OK to confirm.
Tip:
- When playing back disc with copyright protection, the sound will be down sampled to 48 KHz even when you select Down Sampling off.

3D Effects

To obtain expansive virtual surround sound effects from two speakers, set 3D Effects to on. This enhancement sounds only output from the Analogue AUDIO OUT (L / R) jacks of the DVD player.

- In 'Audio', press ▲ / ▼ to select { 3D Effects }, then press ►. You can set to { Off } or { On }.
- Use ▲ / ▼ to select a setting and press OK to confirm.
Tip:
- Only effective in playback of a DVD Video disc with Dolby Digital 5.1 bitstream.

Using the Rating setup menu

- Press SETUP on the remote control.
→ The system setup menu appears.

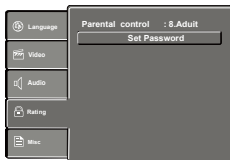

- Press ▲ / ▼ to select { Rating }, then press ►.
- Press ▲ / ▼ to select an item, then press ► to access.

Example: { Parental control }

→ The options for the selected item appears.

→ If the selection in the menu is greyed out, that means the feature is not available or not possible to

Helpful hint: Press ◀ to go back to previous menu item.
Press SETUP to exit the menu item.

DVD Menu Options

change at the current state.

- Use **▲ / ▼** to select a setting and press OK to confirm.

Example: { **8 Adult** }

→ The setting is selected and setup is completed.

- To exit, press SETUP.

Rating Level settings

Depending on the DVD, you may be asked to change the parental level while playing the disc. The rating levels are from 1 to 8 and are country dependent. You can prohibit the playing of certain discs that are not suitable for your children, or have certain discs played with alternative scenes.

- In 'Rating', press **▲ / ▼** to select { **Parental control** }, then press **▶**.
- Use the number buttons to enter the four-digit password, then press OK. (See 'Changing the Password' on this page.)
- Press OK again to list the parental level.

{ **1.Kid Safe** }

Suitable for children.

{ **2. G** }

General Audience; recommended as acceptable for viewers of all ages.

{ **3. PG** }

Parental Guidance suggested.

{ **4. PG-13** }

Unsuitable for children under 13.

{ **5. PG-R** }

Parental Guidance Recommended.

{ **6. R** }

Restricted; under 17 requires accompanying parent or adult guardian.

{ **7. NC-17** }

No one under 17 admitted.

{ **8. Adult** }

DVD softwares of any grades (adult/general/children) can be played back. Should be viewed only by adults due to graphic sexual material, violence or language.

- Use **▲ / ▼** to select a rating level and press OK to confirm.

→ Select { **8 Adult** } to disable parental level and allow all discs to play.

● DVDs that are rated higher than the level you selected will not play unless you enter your four-digit password.

Tips:

-This feature will not limit viewing if the disc manufacturer did not code the disc.

-VCD, SVCD, CD have no level indication, so parental control has no effect on these type of discs.

This also applies to most illegal DVDs.

-Some DVDs are not coded with a rating though the movie rating may be printed on the disc cover. The rating level feature does not prohibit play of such discs.

Changing the Password

You need to enter your four-digit password to play a prohibited disc or if prompted for a password.

- In "Rating", press **▲ / ▼** to select { **Set Password** },

then press OK.

→ You will be prompted to enter your four-digit password.



- Use the number buttons (0-9) to enter the four-digit password.

→ When doing this for the first time, enter the default password '0000'.

- If you forget your old four-digit password, enter the default password '0000'.

- Press OK again to enter the new four-digit password.

→ The new four-digit password will now take effect.



- Press OK to confirm.

Using the Misc (Miscellaneous) setup menu

- Press SETUP on the remote control.

→ The system setup menu appears.

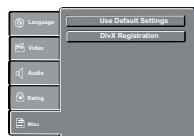

- Press **▲ / ▼** to select { **Misc** }, then press **▶**.

- Press **▲ / ▼** to select an item, then press OK to access.

Example: { **Use Default Settings** }

→ The options for the selected item appears.

→ If the selection in the menu is greyed out, that means the feature is not available or not possible to change at the current state.

- Use **▲ / ▼** to select a setting and press OK to confirm.

Example: { **No** }

→ The setting is selected and setup is completed.

- To exit, press SETUP.

Restoring to original settings

Setting the { **Use Default Settings** } function will reset all options and your personal settings to the factory defaults, except your password and rating level.

- In 'Misc', press **▲ / ▼** to select { **Use Default Settings** }, then press OK.

→ The menu will appear.

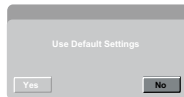

{ **Yes** }

Select this to reset to factory default settings.

Helpful hint: Press **◀** to go back to previous menu item.
Press SETUP to exit the menu item.

{ No }

Select this to close the menu.

- 2 Use ◀/▶ to select a setting and press OK to confirm.

DivX® Registration

DivX® registration code allows you to rent and purchase movies using the DivX® VOD service from the internet.

For more information, visit website:
www.divx.com/vod.

- 1 In 'Misc', press ▲/▼ to select { **DivX Registration** }, then press OK.
→ The registration code will appear.
- 2 Use the registration code to rent or purchase the movies from DivX® VOD.
Registration service at www.divx.com/vod.
→ Follow the instructions and download the movie from your computer onto a CD-R/RW for playback on this DVD player.

Tips:

- All the downloaded movies from DivX® Registration can only be played back on this DVD player.
- Time search feature is not available during DivX® movie playback.

Tray Lock

Press SETUP button, then press the number button "2006" in sequence to lock the tray.

- All functionality of the player and playback remain the same except for the OPEN/CLOSE button.
- After the tray is locked, "Tray Lock Is On" will appear on the screen when OPEN/CLOSE is pressed.
- To unlock the tray, just follow the same procedure as above.

Specifications

DVD Player/Outputs/Supplied Accessories



DVD Player

Power supply	110 V - 240 V AC, 50/60 Hz
Power Consumption	12W(standby :<3W)
Net weight	1.35 kg
External dismensions	360 X 43 X 209 mm (W/H/D)
Signal System	PAL, NTSC
Laser	Semiconductor laser, wavelength 650/780 nm
Frequency range	DVD linear sound : 48 kHz sampling 4 Hz to 22 kHz 96 kHz sampling 4 Hz to 44 kHz
Signal-to-noise ratio	More than 90 dB
Audio dynamic range	More than 80 dB
Harmonic distortion	Less than -65 dB
Wow and flutter	Below measurable level [(less than $\pm 0.001\%$ (W.PEAK))]
Operating conditions	Temperature : 5°C to 35°C Operation status :Horizontal

Outputs

Video output	1.0 V (p-p) , 75 Ω negative sync., pin jack x 1
Video output (SCART)	1.0 V (p-p) , 75 Ω , SCART socket x 1
Component video output	(Y) 1.0 (p-p), 75 Ω negative sync., pin jack x 1 (P B)/(P R) 700 mV (p-p), 75 Ω , pin jack x 2
Audio output (SCART)	2.0 (rms), 680 Ω , SCART socket x 1
Audio output (COAXIAL DIGITAL)	0.5 V (p-p) 75 Ω pin jack x 1
Audio output (ANALOG)	2.0 V (rms), 680 Ω , pin jacks (L/R) x 1

Supplied Accessories

Remote control(SE-R0301)	
Batteries(AAA)	

- The model complies with the above specifications.
- Designs and specifications are subject to change without notice.
- This model may not be compatible with features and /or specifications that may be added in the future.

WARNING

Under no circumstances should you try to repair the DVD player yourself, as this will invalidate the warranty. Do not open the DVD player as there is a risk of electric shock.

If a fault occurs, first check the points listed below before taking the DVD player for repair. If you are unable to remedy a problem by following these guides, consult your dealer or TOSHIBA for help.

Problem	Solution
No power	<ul style="list-style-type: none"> -Check if the AC power cord is properly connected. -Press the I/O ON/STANDBY on the front of the DVD player to turn on the power.
No picture	<ul style="list-style-type: none"> -Refer to your TV's manual for correct Video In channel selection. Change the TV channel until you see the DVD screen. -Check if the TV is switched on. -If the progressive scan feature is activated but the connected TV does not support progressive signals or the cables are not connected accordingly. See pages 12-13 for proper progressive scan set up or deactivate the progressive scan feature as follow: <ol style="list-style-type: none"> 1) Press OPEN/CLOSE on the DVD Player. 2) When the disc tray is opened, press number button '1' on the remote control for a few seconds.
Distorted picture	<ul style="list-style-type: none"> -Sometimes a small amount of picture distortion may appear depending on the disc being played back. This is not malfunction.
Picture clipped	<ul style="list-style-type: none"> -May be caused by View Mode Setting (see page 19). Set to Original for normal viewing.
Completely distorted picture or black /white picture with DVD.	<ul style="list-style-type: none"> -Connect DVD Player directly to the TV. -Make sure the disc is compatible with the DVD player. -Ensure that the DVD Player's setting is set to match that of the disc and your TV.
No sound / distorted sound	<ul style="list-style-type: none"> -Adjust the volume. -Check that the speakers are connected correctly.
No audio at digital output	<ul style="list-style-type: none"> -Check the digital connections. -Check if your receiver can decode MPEG-2 or DTS and if not, please make sure the digital output is set to PCM. -Check if the audio format of the selected audio language matches your receiver capabilities.
No sound and picture	<ul style="list-style-type: none"> -Check that the cable is connected to the correct device (See Connecting to television).
Disc cannot be played	<ul style="list-style-type: none"> -The DVD±R/RW must be finalized. -Ensure the disc label is facing up. -Check if the disc is defective by trying another disc. -Wrong region code.
Picture freezes momentarily during playback	<ul style="list-style-type: none"> -Check the disc for fingerprint/scratches and clean with a soft cloth wiping from centre to edge.
No return to start-up screen when disc is removed	<ul style="list-style-type: none"> -Reset the unit by switching the player off, then on again.
The player does not respond to the Remote Control	<ul style="list-style-type: none"> -Aim the Remote Control directly at the sensor on the front of the player. -Reduce the distance to the player. -Replace the batteries in Remote Control. -Re-insert the batteries with their polarities(+/- signs)as indicated.
Buttons do not work	<ul style="list-style-type: none"> -To completely reset the player, unplug the AC cord from AC outlet for 5-10 seconds.

Troubleshooting

Problem	Solution
Player does not respond to some operating commands during playback.	-Operations may not be permitted by the disc. Refer to the instructions of the disc jacket.
DVD Player cannot read CDs /DVDs	-Use a commonly available cleaning CD/DVD to clean the lens before sending the DVD Player for repair.
Menu items cannot be selected	-Press STOP twice before selecting system setup menu. -Depending on the disc availability, some menu items cannot be selected.
Unable to select Progressive Scan on/off	-Ensure that the output of the Video Out signal is switch to P-Scan/Component.

Analogue audio:

An electrical signal that directly represents sound. In contrast, digital audio can also be an electrical signal, but is an indirect representation of sound. See also Digital audio.

Aspect ratio:

The width of a TV screen relative to it is height. Conventional TVs are 4:3 (i.e., the screen is almost square). Widescreen models are 16:9 (the screen is almost twice as wide as its height)

Chapter:

Just as a book is split up into several chapters, a title on a DVD disc is usually divided into chapters. See also Title.

AUDIO OUT jacks:

Jacks on the back of the DVD System that send audio to another system (TV, Stereo, etc.)

Bite rate:

The amount of data used to hold a given length of music; measured in kilobits per seconds, or kbps. Or, the speed at which you record. Generally, the higher the bite rate, or the higher the recording speed, the better the sound quality. However, higher bite rates use more space on a disc.

Disc menu:

A screen display prepared for allowing of selection of images, sound, subtitle, multi-angles etc. recorded on the DVD.

Digital audio:

An indirect representation of sound using numbers. During recording, the sound is measured at discrete intervals (44, 100 times a second for CD audio) by an analogue-to-digital converter, generating a stream of numbers. On playback, a digital-to-analogue converter generates an analogue signal based on these numbers. See also Sampling frequency and Analogue audio.

DivX®:

DivX® is a codec (compression/decompression) that can compress images to a very small amount of data.

Dolby® Digital:

A system developed by Dolby Laboratories that compresses digital sound. It works with stereo (2ch) or multi-channel audio.

DTS®:**(Digital Theater System)**

DTS is a Multi-channel surround sound system, but it is different from Dolby Digital. Both formats were developed by Digital Theater Systems, Inc.

JPEG:**(Joint Photographic Experts Group)**

JPEG is a method of compressing still image files. You can copy JPEG files on CD-RW / R discs from a computer and play back the files on this unit.

Multichannel:

DVD is specified to have each sound track constitute one sound field. Multichannel refers to a structure of sound tracks having three or more channels.

Parental control:

A function of the DVD to limit playback of the disc by the age of the users according to the limitation level in each country. The limitation varies from disc to disc; when it is activated, playback will be prohibited if the software's level is higher than the user-set level.

PBC (Video CD only):**(Playback Control)**

This function enables you to play back interactive software using a menu screen. See also Title.

Progressive scan:

It displays all the horizontal lines of a picture at one time, as a signal frame. This system can convert the interlaced video from DVD into progressive format for connection to a progressive display. It dramatically increases the vertical resolution.

PCM:**(Pulse Code Modulation)**

PCM is a format that converts audio into digital data. It is mainly used for Audio CDs and DAT. This unit can play back sounds as realistic as possible by converting even compressed Dolby Digital and MPEG audio to PCM.

Region code:

Regions associate discs and players with particular areas of the world. This unit will only play back discs that have compatible region codes. You can find the region code of your unit by looking on the rear panel. Some discs are compatible with more than one region (or all regions).

Sampling frequency:

The rate at which sound is measured by a specified interval to turn it into digital audio data. The number of samples in one second is defined as the sampling frequency. The higher the rate is, the better the possible sound quality.

Title:**(DVD)**

A collection of chapters on a DVD. See also chapter.

(Video CD)

The contents of a Video CD. When playing back a Video CD with the PBC function, the title menu will appear automatically.

Track:

Audio CDs and Video CDs use tracks to divide the contents of a disc. The DVD equivalent is called a chapter. See also Chapter.